

# Data Sheet



Article number: 0125061

Description: Retaining ring SP44  
Spring steel

## Measures

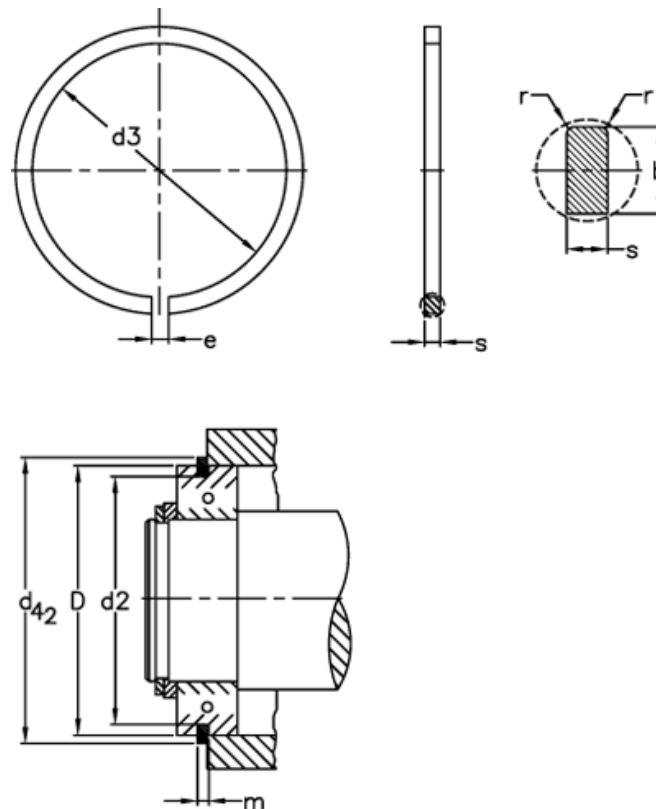

b	= 3.25	FRg kN	= 2.29	tol	= -0.15
D	= 44	FR kN	= 12.4	tol	= -0.1
d2	= 41.75	g	= 2.0	tol	= -0.25
d3	= 40.9	K kN-mm	= 22.6	tol	= 0.3
d42	= 48.3	m	= 1.35	tol	= 0.5
Description	= SP 44	n abl x 1000	= 7.0	Weight kg/1000	= 4.0
e	= 3	r min	= 0.4		
FN kN	= 24.6	s	= 1.12		